

## Représentation des filetages

### .I Vocabulaire

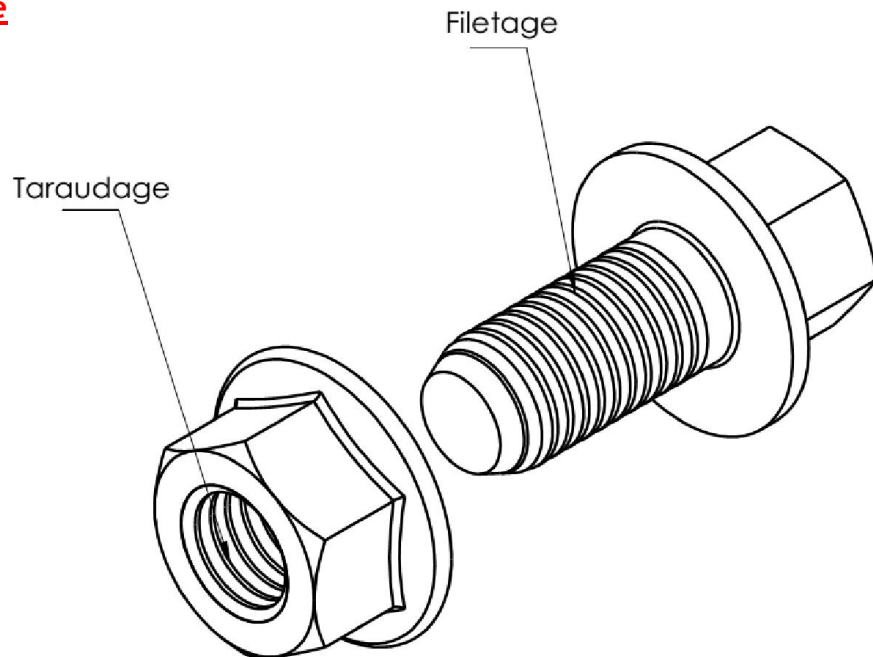

### .II Filetage

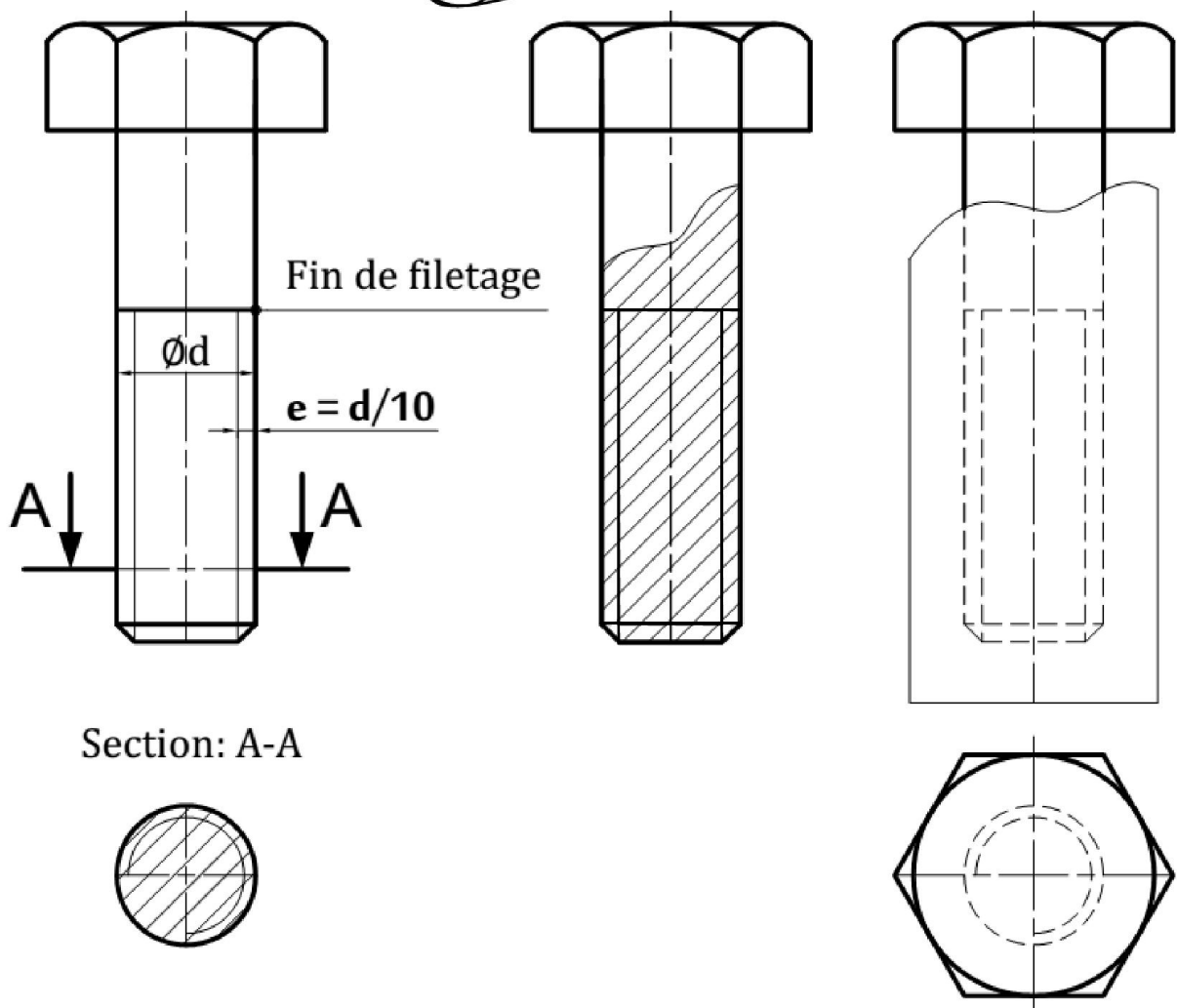

## .III Taraudage

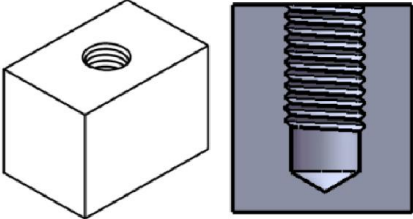
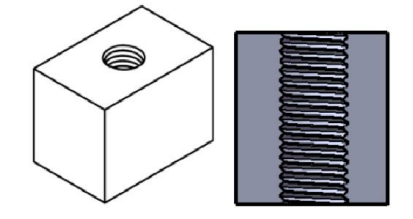
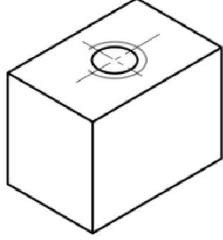
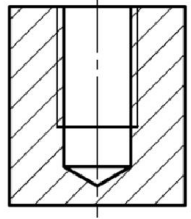
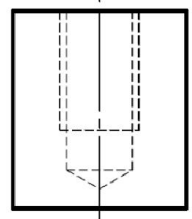
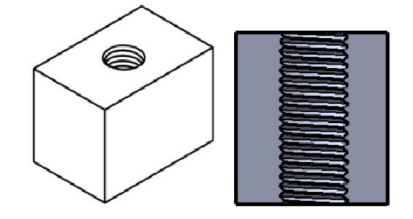
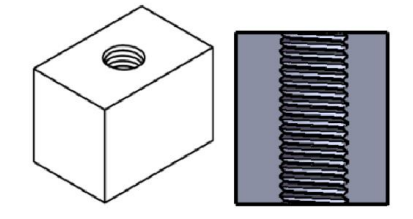
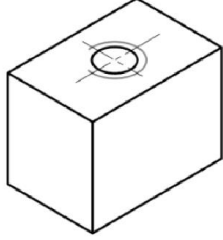
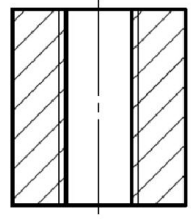
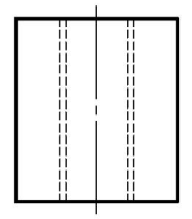
| <i>Représentation réelle</i>  |   | <i>Représentation simplifiée</i>  |  |   |
|---|---|---|--|---|
|  |  |  |  |  |
|  |  |  |  |  |
|   |   | <i>En perspective</i>   | <i>En coupe</i>  | <i>S'il est caché</i>   |

## .IV Assemblage des pièces Filetées

La représentation de la vis est prépondérante

### IV-1 Trou débouchant

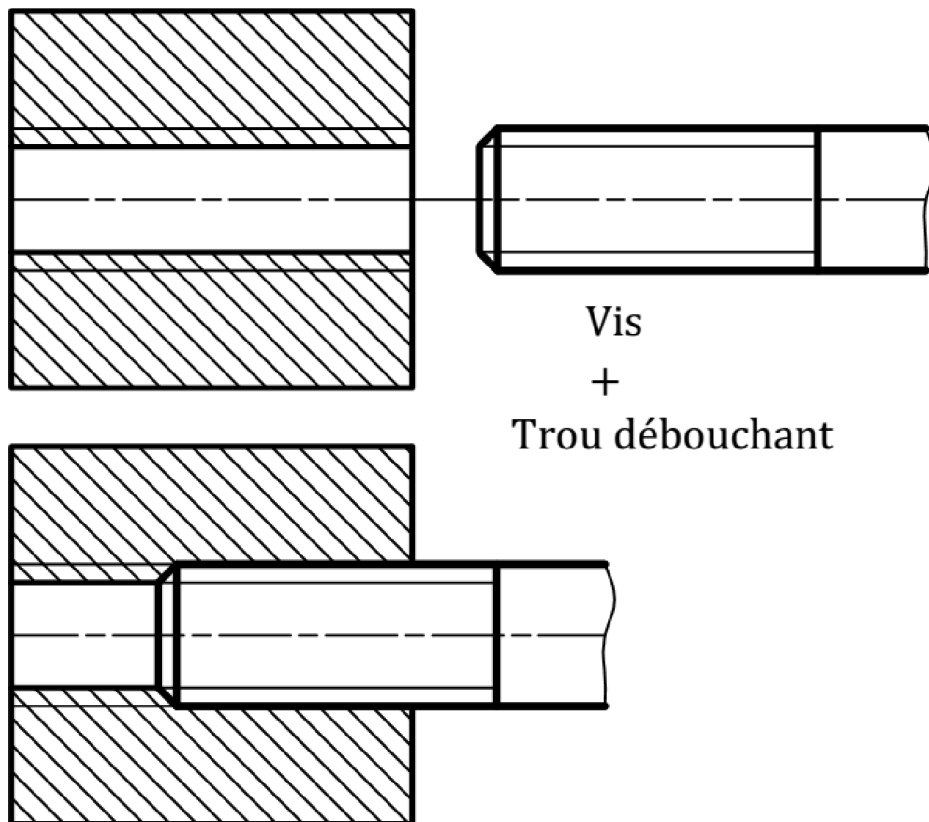

## IV-2 Trou borne

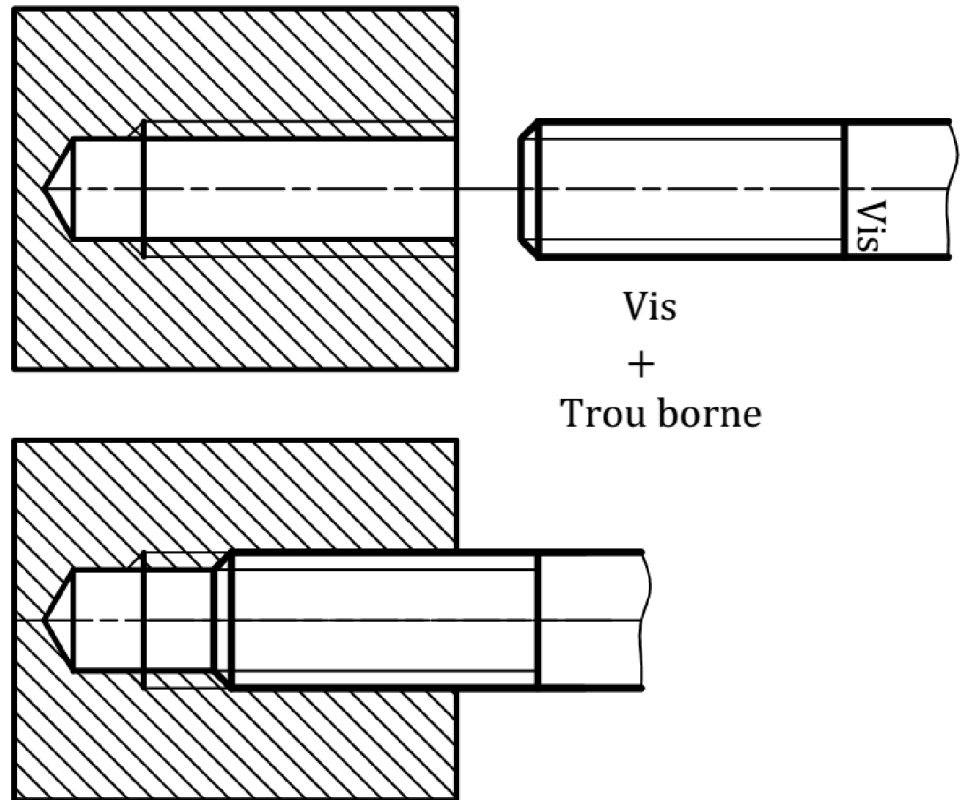

## IV-3 Application

Compléter l'assemblage suivant:

