

Ampoule type "navette"

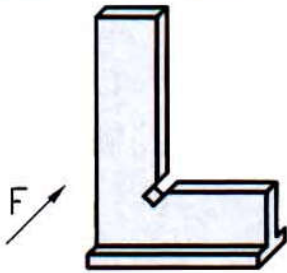

Equerre à chapeau

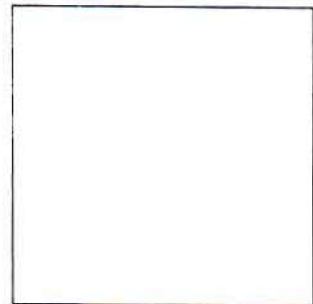
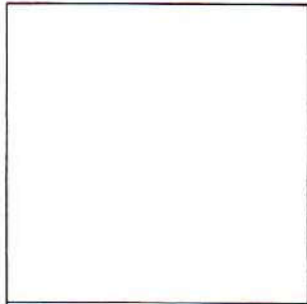
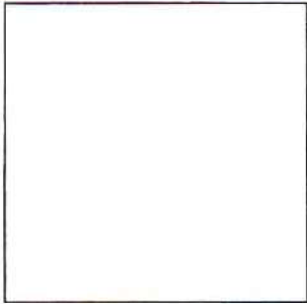
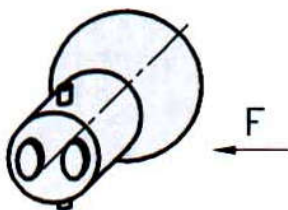
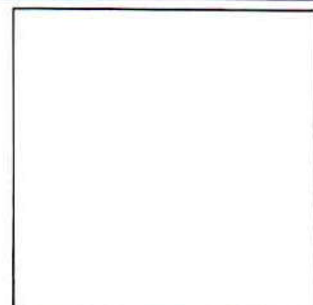
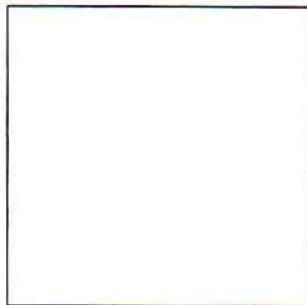
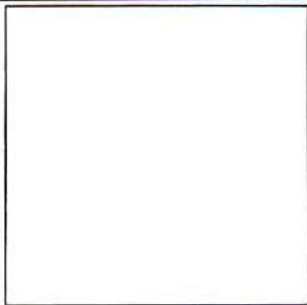

Ampoule de clignotant pour automobile

CORRECTION	REPRESENTATION GRAPHIQUE	L.P. P. MENDES FRANCE
EXERCICES	PROJECTION ORTHOGONALE	DR1

Corrigé

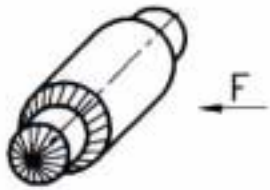
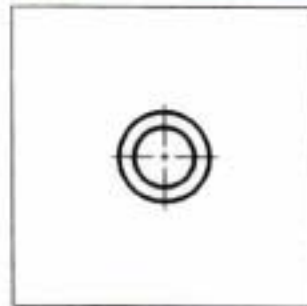
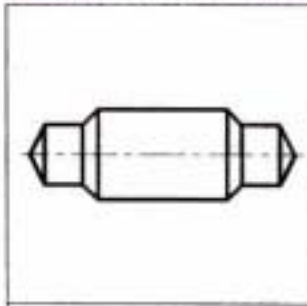
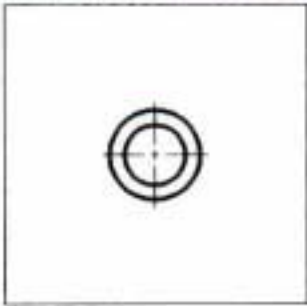

Ampoule type "navette"

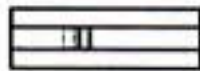
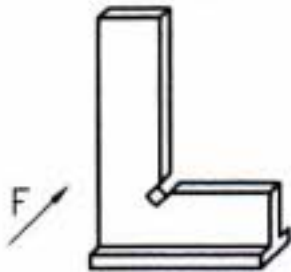
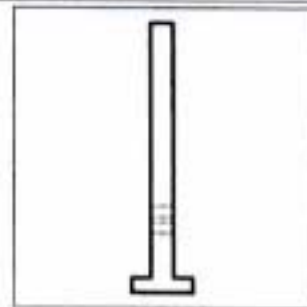
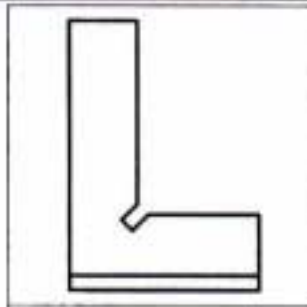

Equerre à chapeau

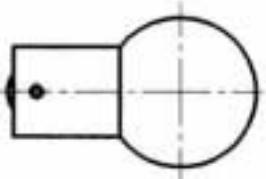
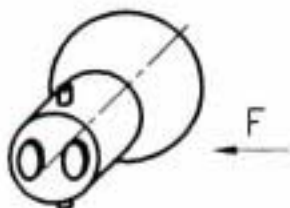
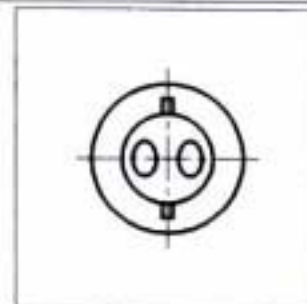
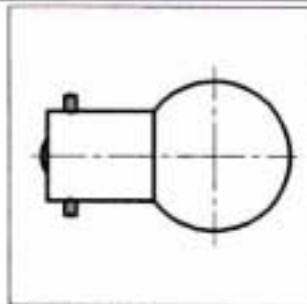
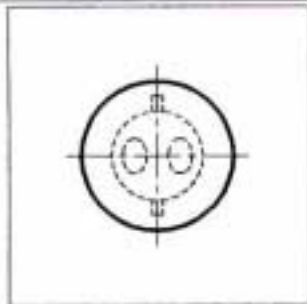

Ampoule de clignotant pour automobile